

ACHTUNG!!!
Pos. 18 und 19 müssen
gemeinsam getauscht werden!

CAUTION!!!
Pos. 18 and 19 have to be
changed together!

ENTHALTEN IM DICHTSATZ MOTOR
INCLUDED IN GASKET SET ENGINE

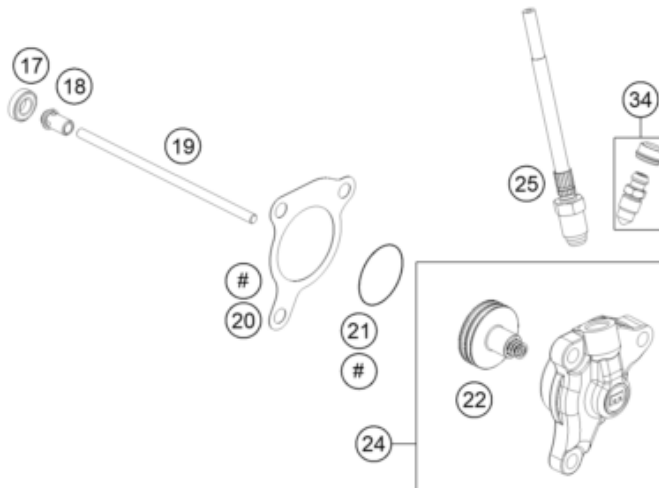
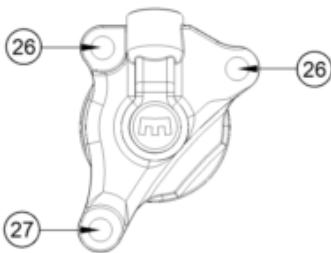

Pos	Part Number	Description	Additional Text	Quantity
1	014580050306	Cyl.screw DIN14580 M5x30		4.00
2	76632006000	Anticentrifugal ring		1.00
3	58532080001	CLUTCH SPRING 3,0X33,5		4.00
4	76632003044	pressure plate		1.00
5	60036073150	hex nut M20x1,. H=6mm		1.00
6	75032018100	Lock washer		1.00
7	76632002102	Movable Hub		1.00
8	75032033000	CLUTCH RELEASE SPRING		4.00
9	76632002101	Fixed Hub		1.00
10	75032009000	STEPPED WASHER 07		1.00
11	75032007000	HALF-WASHER 07		2.00

12	75032001244	Clutch housing cpl.	1.00
14	75032050001	OIL PUMP DRIVE WHEEL 07	1.00
15	56532095000	NEEDLE BEARING K26X30X22ZW.KSE	1.00
16	75032017000	WASHER 26X40X2 07	1.00
17	0625060016	deep groove ball bearing 6001.	1.00
18	75032055100	PRESSURE BOLT 08	1.00
19	75032054200	PUSH ROD 08	1.00
20	59032065100	GASKET F. OUTPUT CYLINDER	1.00
21	0770300015	O-ring 30x1.5 NBR 70	1.00
22	76132066000	Piston kit output Cyl. Dot Cpl	1.00
24	76132061044	Output Cyl. Dot Cpl. 27mm	1.00
25	76032063000	CLUTCH PIPE 1100MM	1.00
26	0025060206	HH collar screw M6x20 TX30	2.00
27	0025060356	HH collar screw M6x35 TX30	1.00
28	75032112000	STEEL DISK 1,5 MM LC4 '07	6.00
29	76632011000	LINING DISK 2,7MM FCC 02	7.00
30	58632016000	RONDELLA ANTIVIBRAZIONE SET	1.00
31	76632010000	LINING DISC CUT OUT	1.00
32	75032112100	STEEL DISK 1,5MM NITRIDED	1.00
33	75032032000	HOLDING SCREW GMB-M5X35	2.00
34	54732064000	BLEEDER SCREW WITH CAP	1.00
99	76632010033	Clutch Disk Kit without spring	1.00