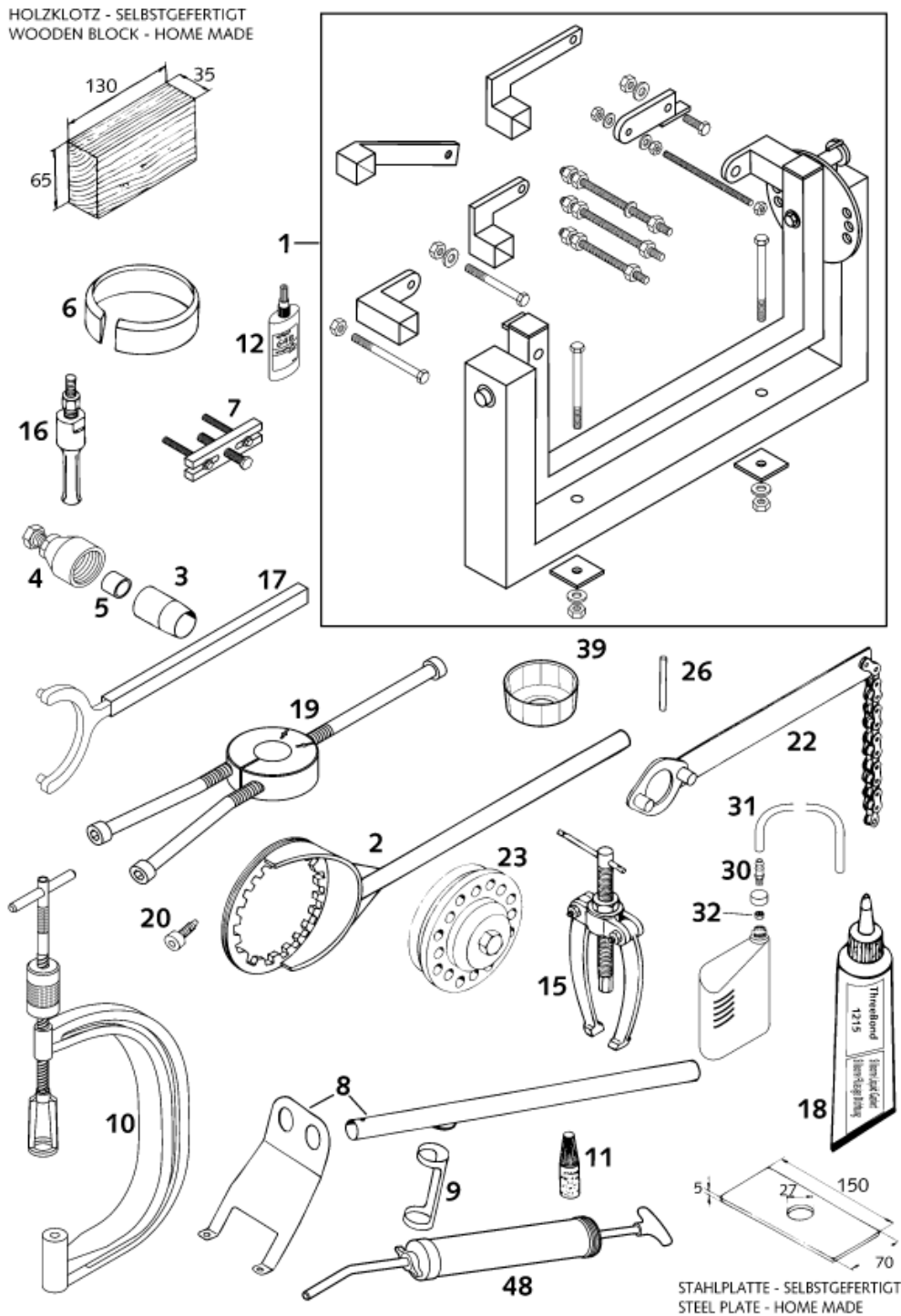

HOLZKLOTZ - SELBSTGEFERTIGT
 WOODEN BLOCK - HOME MADE

 STAHLPLATTE - SELBSTGEFERTIGT
 STEEL PLATE - HOME MADE

Pos	Part Number	Description	Additional Text	Quantity
1	56012001000	ASSY SUPPORT (WITHOUT HOLDER)		1.00
2	58329003000	CLUTCH HOLDER D=160MM LC4'94		1.00
3	58012005025	MOUNTING SLEEVE D=25MM	FOR CRANKSHAFT SEAL L/S	1.00
4	58429009000	MAGNETO EXTRACTOR		1.00
5	58429031000	PROTECTOR CAP F.CRANKSHAFT M16		1.00
6	58012015089	PISTON RING COMPRESSOR D=89MM	350/400 LC4	1.00
7*	59029021000	EXTRACT.PRIM.GEAR-INNER CLUT	F.PRIM.GEAR D.INNER CLUTCHHUB	1.00
8	58012019000	VALVE INSTALLATION KIT		1.00
9	6276470	PUSH INSERT		1.00

10*	59029019000	VALVE SPRING LEVER		1.00
11	6899785	LOCTITE 243 BLUE 5 ML		0.00
12	58429059000	LOCTITE 648 GREEN 10ML		0.00
15	15112017000	BUSHING EXTRACTOR		1.00
16	15112018000	INTERN.BEAR.PULLER 12-16 MM		1.00
16	15112018100	INTERN.BEAR.PULLER 18-23 MM		1.00
17	58429012000	HOLDING WRENCH FOR WHEEL		1.00
18	309098	SILICON GASKET THREE-BOND		1.00
19*	58429037040	MOUNTING TOOL F.BEARING NJ 306		1.00
19*	58429037043	MOUNTING TOOL F.BEARING NJ 207		1.00
20	58030080000	LOCATING SCREW M8 L=23	450/525 MXC, EXC	1.00
22	51012012000	HOLDING SPANNER FOR SPROCKET		1.00
23	54629027000	RIVETTING TOOL FOR CLUTCH		1.00
26	58029026007	LIMIT PLUG GAUGE F.VALVE GUIDE	D=7,05MM	1.00
30	59030022000	BLEEDER FLANGE M8 WS=10 '99		1.00
31	31007107001	PVC-HOSE 6X9 MM PER METER	BREATHING HOSE	0.00
32	0934080003	Hexagon nut DIN934 M8		1.00
39	58329039000	WRENCH SCREW FILTER		1.00
48	58429048000	INJEKTION FOR FRONT PIPE '99	DEAERATE FOR FRONT PIPE	1.00

* = New part