

HOLZKLOTZ - SELBSTGEFERTIGT  
 WOODEN BLOCK - HOME MADE

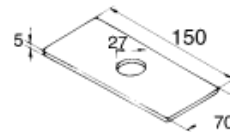
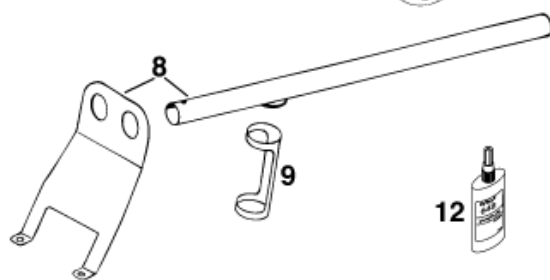
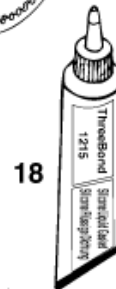
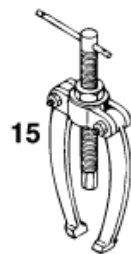
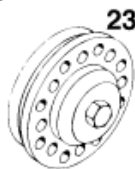
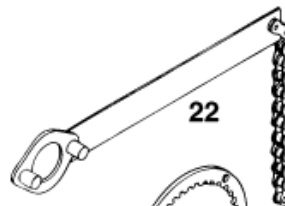
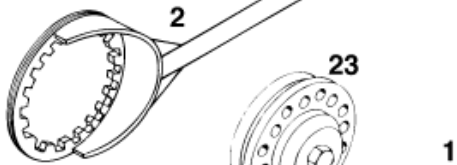
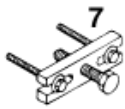
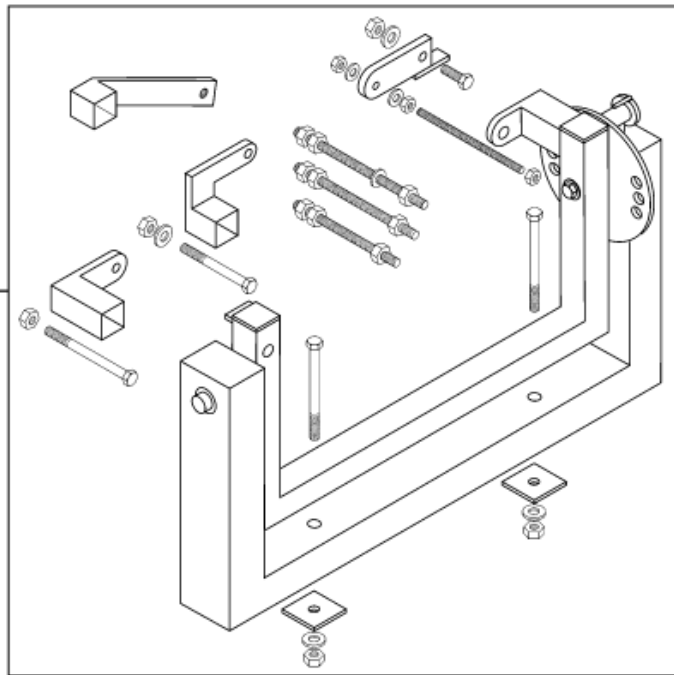
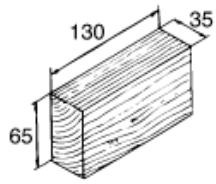

STAHLPLATTE - SELBSTGEFERTIGT  
 STEEL PLATE - HOME MADE

Pos	Part Number	Description	Additional Text	Quantity
1	56012001000	ASSY SUPPORT (WITHOUT HOLDER)		1.00
2	58329003000	CLUTCH HOLDER D=160MM LC4'94		1.00
3	58012005025	MOUNTING SLEEVE D=25MM	FOR CRANKSHAFT SEAL L/S	1.00
4	58012009000	FLYWHEEL EXTRACTOR	660 SMS	1.00
5	51012016000	PROTECTION CAP CRANKSHAFT M12		1.00
6	58012015089	PISTON RING COMPRESSOR D=89MM	350/400 LC4	1.00
6	58012015090	PISTON RING COMPRESSOR D=90MM		1.00
6	58012015095	PISTON RING COMPRESSOR D=95MM		1.00
6	58012015100	PISTON RING COMPRESSOR D=100MM		1.00
6	58012015101	PISTON RING COMPRESSOR D=101MM	620/640 LC4	1.00

7	16012005000	EXTRACTOR	F.PRIM.GEAR D.INNER CLUTCHHUB	1.00
8	58012019000	VALVE INSTALLATION KIT		1.00
9	6276470	PUSH INSERT		1.00
11	6899785	LOCTITE 243 BLUE 5 ML		0.00
12	58429059000	LOCTITE 648 GREEN 10ML		0.00
13	58012003000	CLUTCH HOLDER D=153MM		1.00
15	15112017000	BUSHING EXTRACTOR		1.00
16	15112018000	INTERN.BEAR.PULLER 12-16 MM		1.00
16	15112018100	INTERN.BEAR.PULLER 18-23 MM		1.00
18	309098	SILICON GASKET THREE-BOND		1.00
20	58030080000	LOCATING SCREW M8 L=23	450/525 MXC, EXC	1.00
22	51012012000	HOLDING SPANNER FOR SPROCKET		1.00
23	54629027000	RIVETTING TOOL FOR CLUTCH		1.00
26	58029026007	LIMIT PLUG GAUGE F.VALVE GUIDE	D=7,05MM	1.00
39	58329039000	WRENCH SCREW FILTER		1.00