

HOLZKLOTZ - SELBSTGEFERTIGT
WOODEN BLOCK - HOME MADE

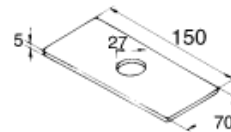
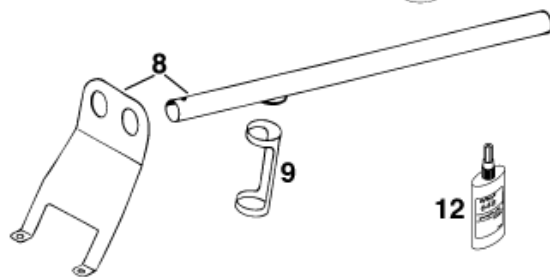
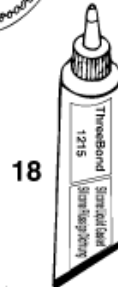
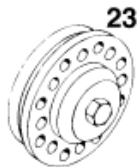
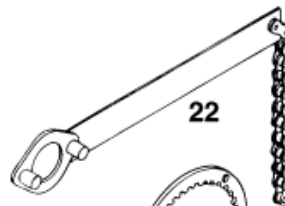
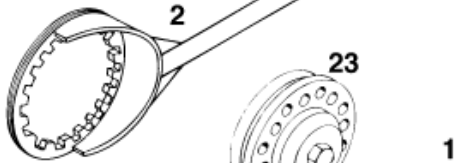
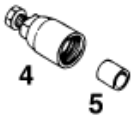
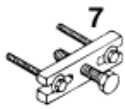
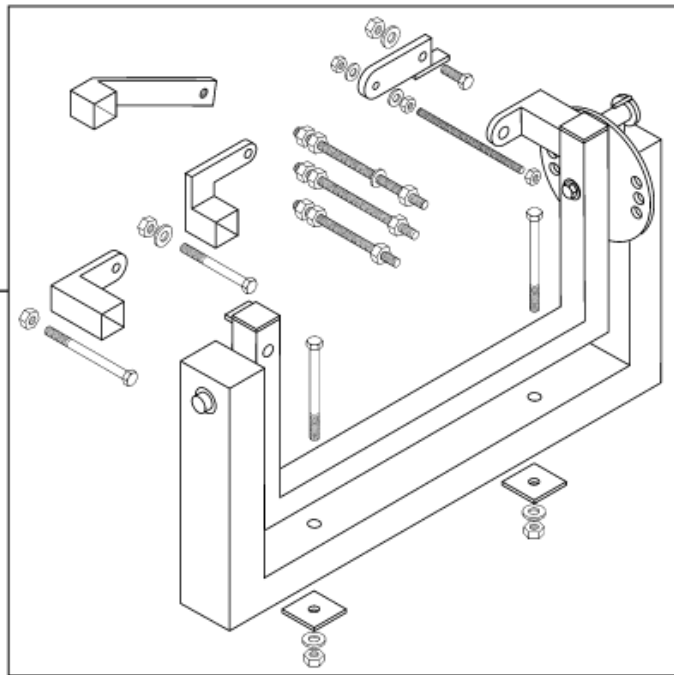
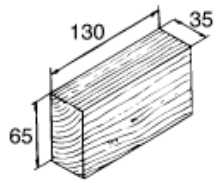

STAHLPLATTE - SELBSTGEFERTIGT
STEEL PLATE - HOME MADE

| Pos | Part Number | Description | Additional Text | Quantity |
|-----|-------------|--------------------------------|-------------------------|----------|
| 1 | 56012001000 | ASSY SUPPORT (WITHOUT HOLDER) | | 1.00 |
| 2 | 58329003000 | CLUTCH HOLDER D=160MM LC4'94 | | 1.00 |
| 3 | 58012005025 | MOUNTING SLEEVE D=25MM | FOR CRANKSHAFT SEAL L/S | 1.00 |
| 4 | 58012009000 | FLYWHEEL EXTRACTOR | 660 SMS | 1.00 |
| 5 | 51012016000 | PROTECTION CAP CRANKSHAFT M12 | | 1.00 |
| 6 | 58012015089 | PISTON RING COMPRESSOR D=89MM | 350/400 LC4 | 1.00 |
| 6 | 58012015090 | PISTON RING COMPRESSOR D=90MM | | 1.00 |
| 6 | 58012015095 | PISTON RING COMPRESSOR D=95MM | | 1.00 |
| 6 | 58012015100 | PISTON RING COMPRESSOR D=100MM | | 1.00 |
| 6 | 58012015101 | PISTON RING COMPRESSOR D=101MM | 620/640 LC4 | 1.00 |

| | | | | |
|----|-------------|--------------------------------|----------------------------------|------|
| 7 | 16012005000 | EXTRACTOR | F.PRIM.GEAR D.INNER CLUTCHHUB | 1.00 |
| 8 | 58012019000 | VALVE INSTALLATION KIT | | 1.00 |
| 9 | 6276470 | PUSH INSERT | | 1.00 |
| 11 | 6899785 | LOCTITE 243 BLUE 5 ML | | 0.00 |
| 12 | 58429059000 | LOCTITE 648 GREEN 10ML | | 0.00 |
| 13 | 58012003000 | CLUTCH HOLDER D=153MM | | 1.00 |
| 15 | 15112017000 | BUSHING EXTRACTOR | | 1.00 |
| 16 | 15112018000 | INTERN.BEAR.PULLER 12-16 MM | | 1.00 |
| 16 | 15112018100 | INTERN.BEAR.PULLER 18-23 MM | | 1.00 |
| 18 | 309098 | SILICON GASKET THREE-BOND | | 1.00 |
| 20 | 58030080000 | LOCATING SCREW M8 L=23 | 450/525 MXC, EXC | 1.00 |
| 22 | 51012012000 | HOLDING SPANNER FOR SPROCKET | | 1.00 |
| 23 | 54629027000 | RIVETTING TOOL FOR CLUTCH | | 1.00 |
| 26 | 58029026007 | LIMIT PLUG GAUGE F.VALVE GUIDE | D=7,05MM | 1.00 |
| 39 | 58329039000 | WRENCH SCREW FILTER | | 1.00 |