

19

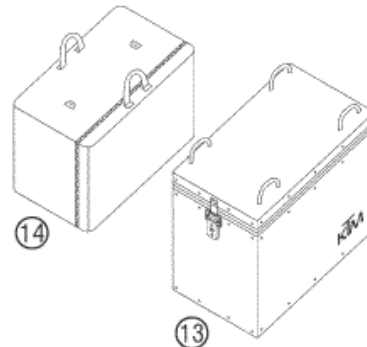

14

13

(OHNE ABBILDUNG / WITHOUT ILLUSTRATION)

15 GEPÄCKTRÄGER-SYSTEM KPL. (STAHLROHR)  
SUITCASE-CARRIER-SYSTEM CPL. (STEEL-TUBE)

16 GEPÄCKTRÄGER EINZELTEILE  
SUITCASE-CARRIER SINGLE PARTS

17 GEPÄCKHAKEN-SET  
LUGGAGE-BRACKET-KIT

18 BENZINHAHN (FÜR WASSER)  
FUEL COCK (FOR WATER)

# ERSATZSCHLÜSSEL AUF ANFRAGE (SCHLÜSSEL-CODE)  
SPARE KEY ON REQUEST (KEY-CODE)

(OHNE ABBILDUNG / WITHOUT ILLUSTRATION)

15 GEPÄCKTRÄGER-SYSTEM KPL. (STAHLROHR)  
SUITCASE-CARRIER-SYSTEM CPL. (STEEL-TUBE)

16 GEPÄCKTRÄGER EINZELTEILE  
SUITCASE-CARRIER SINGLE PARTS

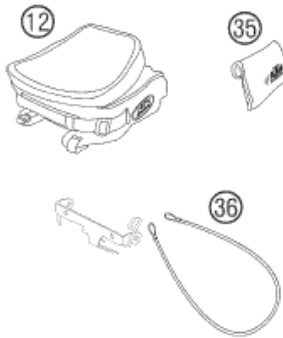

12

35

36

4

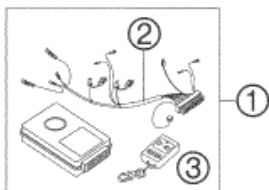

2

1

3

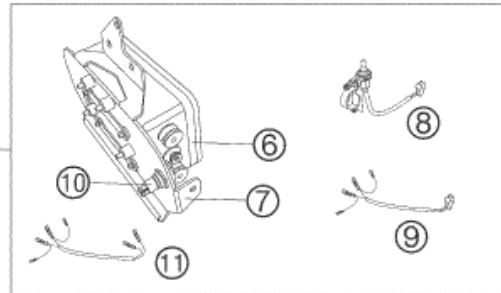

5

6

8

10

7

9

11

(OHNE ABBILDUNG / WITHOUT ILLUSTRATION)

20 MONTAGE-KIT (U-BLECH, SCHRAUBEN, DISTANZEN)  
MOUNTING-KIT (U-BRACKET, SCREWS, SPACERS)

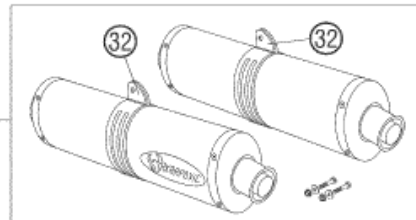

31

32

32

(OHNE ABBILDUNG / WITHOUT ILLUSTRATION)

33 REPARATUR-KIT (DÄMMSTOFF, NIETEN, TITANHÜLLE)  
REPAIR-KIT (STUFFING YARN, RIVET, TITAN-HOUSING)

34 DÄMMSTOFF  
STUFFING YARN

Pos	Part Number	Description	Additional Text	Quantity
1	60012035000	ALARM SYSTEM LC8 CPL. 03		1.00
2	60012036000	WRING HARNESS ALRM SYSTEM 03		1.00
3	60012037000	SPARE REM. COTR. ALARM SYS.03		1.00
4	58214069044	TRIPMASTER SWITCH CPL. ADV. 02		1.00
5	60012073044	ROADBOOK CARRIER KIT CPL. 03		1.00
6	60012073000	ROADBOOK LOOSE 03		1.00
7	60012073050	ROADBOOK BRACKET 03		1.00
8	60012073080	REMOTE CONTROL ROADBOOK 03		1.00
9	60012073060	WIRING HARNESS ROADBOOK 03		1.00
10	60011042000	VEHICLE ELECTRICS CONNECTOR 03		1.00
11	60011042050	WRNG HAR. VEH.ELECTR.CON. 03		1.00

12	60012019000	% TANK BAG 950 ADVENTURE		1.00
13	60012024000	ALUMINUM CASE 35 LITER 03		2.00
13	60012024100	ALUMINUM CASE 41 LITER 03		2.00
14	58412010350	% INSIDE POCKET 35 L	L/S	2.00
14	58412010351	% INSIDE POCKET 41 L	R/S	2.00
15	60012020000	% SUITCASE CARRIER SYSTEM 03		1.00
16	60012020050	% CASE RACK LEFT 03		1.00
16	60012020060	% CASE RACK RIGHT 03		1.00
16	60012020070	CONNECTING COMPONENT 03		1.00
16	60012020080	MOUNTING KIT CASE RACK 03		1.00
17	60012025090	LUGGAGE BRACKET SET 03		2.00
18	58507003000	FUEL COCK CPL. SM. RALLYE'96		2.00
19	60012025000	% CASE SET ADVENTURE		1.00
20	60012073070	MOUNTING KIT ROADBOOK 03		1.00
31	60005099000	SILENCER-SET TITANIUM LS+RS 03		1.00
32	60005099001	CARBON CLAMP 03		2.00
33	60005099002	REPAIR-KIT		2.00
34	58705099202	STUFFING YARN KIT 03		2.00
35*	61029099000	TOOL SET 950/990 05		1.00
36	60012015000	HELMET LOCK 04		1.00

\* = New part